

JPS Lifts
DESIGN
INSTALLATION
SERVICE
MODERNISATION

Enjoy your home **without barriers.**

HOMELIFT SOLUTIONS

We are Orona, your best travel companion

You are in good hands, the best hands.

We are Orona, a leading business group in sustainable vertical passenger mobility solutions; every day we help more than 25 million people reach their destinations around the world.

Our objective is to bring people together, shortening the distances that separate them.

A leader in elevation that puts the best of its knowledge at your disposal:

- Extensive experience throughout the entire vertical lift value chain
- The plant with the largest production capacity for complete lifts in Europe
- Lifting solutions designed and manufactured in Europe for the world

A committed partner:

- Social commitment, cooperative: people who work with people. We are united by our values.

A number is worth a thousand words

+30,000
units per year
production
capacity

No. 1
in complete lift
production capacity
in Europe

60
years of
experience

+300,000
lifts worldwide with
Orona technology

Getting closer, our way to be and our way of doing.

JOIN THE...

world leader in the distribution of complete lifts with a presence in more than 100 countries through local partners and long-standing relationships.

A MODEL BASED ON...

comprehensive support, providing its partners with first-class technical assistance.

COLLABORATION IN...

solving the major challenges of the **value chain** through access to processes and applications that provide competitiveness and differentiating features.

COMMITMENT...

in ensuring our partners have access to the latest market trends through our continued **investment in R&D**.

Join the Orona Next Experience, where the journey is the destination, live your own story.

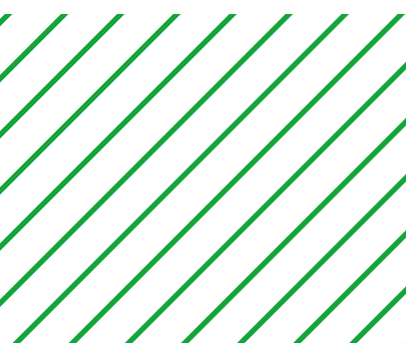
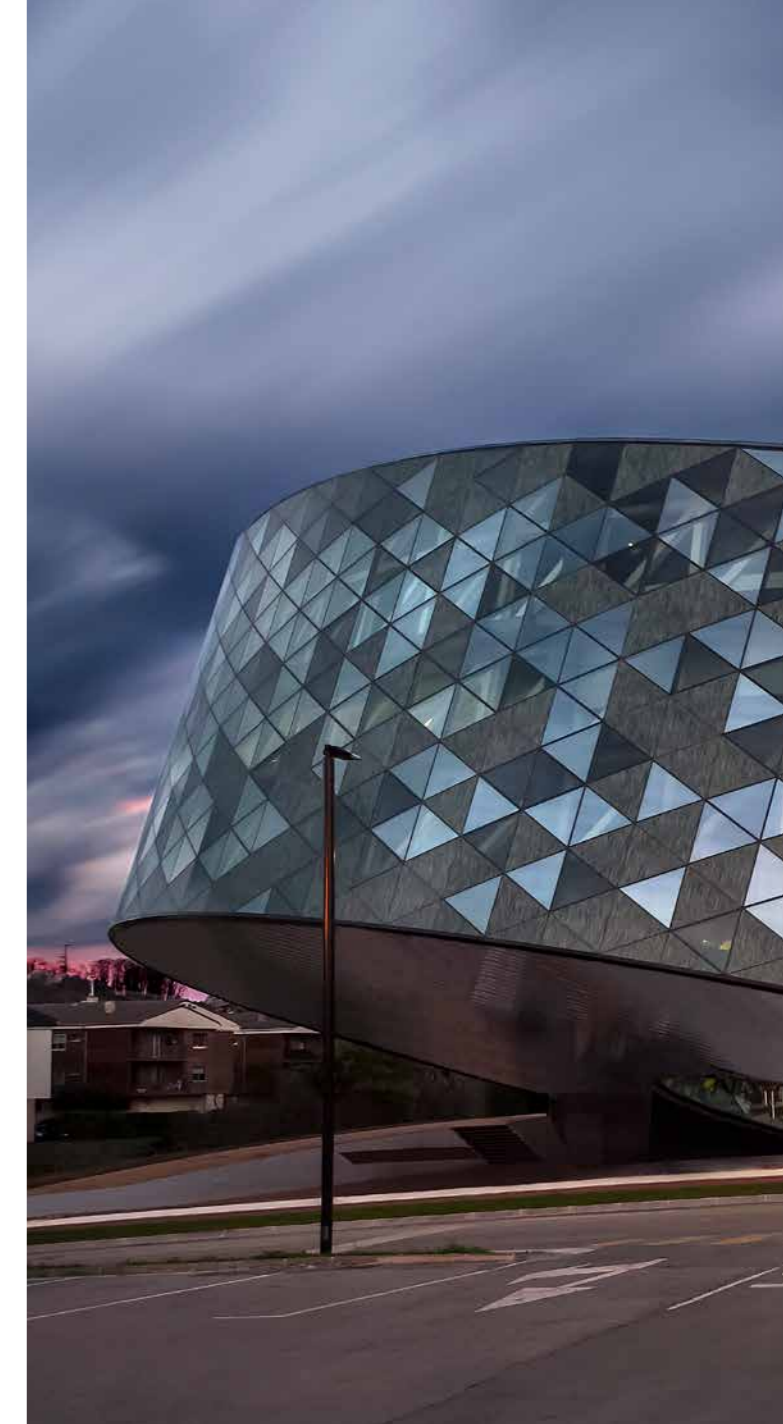

Comfort and design go hand in hand.

Move freely in your own home.

Imagine waking up in the morning and effortlessly gliding down to the kitchen from your bedroom on the top floor of your home. Enjoying the smell of freshly-made coffee that comforts you as you start a new day full of new emotions.

Well, this comfort and convenience can be a part of your everyday life, thanks to Orona Next, the platform of mobility solutions for people in buildings, which makes it possible for Orona to fulfil its aim each and every day: to bring people together and to shorten the distances separating them. A platform of solutions comprised of lifts and accessibility products, as well as four ranges of options to adapt to your needs.

DESIGNED TO TAKE CARE OF YOU

Solutions that contribute to your well-being on board our homelift cars, because our aim is to bring people together and shorten distances, looking after you and your loved ones throughout your trip.

A UNIVERSAL ACCESSIBILITY SPACE

Accessibility elements to ensure that your homelift is a universal space, so that it can be used by everyone in safe, comfortable conditions and in the most natural and independent manner.

WE PUT ALL OUR ENERGY AT THE SERVICE OF SUSTAINABILITY

We design and integrate all systems to reduce the energy consumption of your solution, thinking about today and tomorrow, because sustainability is a part of who we are.





We take care of you.

Trust is at the core of all we do.

Listening and solving is our starting point for building a relationship of trust with our customers. And it guarantees we will be here to offer you the best solution for your home, whether you have plenty of free space or just one square metre.

We offer you a safe, elegant lifting solution with cutting-edge technological design for smooth, efficient journey. Your homelift cabin will be perfectly levelled with the floor you travel to, which is good news if you need to use a pushchair or wheelchair. It also meets the highest safety standards to guarantee peace of mind for you and your loved ones.

The **Orona Next Home** solution uses energy-efficient components to assure a longer life for your homelift and to contribute to improving people's safety, accessibility and comfort while respecting the environment. Our homelifts have efficient lighting with an automatic switch-off system, so that the cabin light will only be on when you're using the homelift.

Home Domestic solutions.

General Specifications

Load	320 - 400 kg
Capacity	3 - 4 - 5 persons
Speed	0.3 m/s
Maximum Travel	12 m
Machine-room Option	No
Entrances	1 front 2 open through / 2 front & side
Drive System	Regulated gearless (90 stars per hour)
Controller	ARCA III controller, low energy consumption multiprocessor
Door Types	Automatic side-opening Automatic centre-opening
Clear door opening	700 / 750 / 800 / 900 mm
Door Height	2000 / 2100 mm
Internal Car Height	2000 / 2100 / 2200 mm
Power Supply	Single-phase
Control and security	Automatic rescue always active

1 Entrance

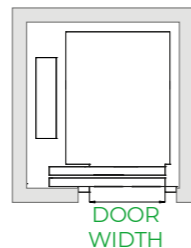

Vertical section

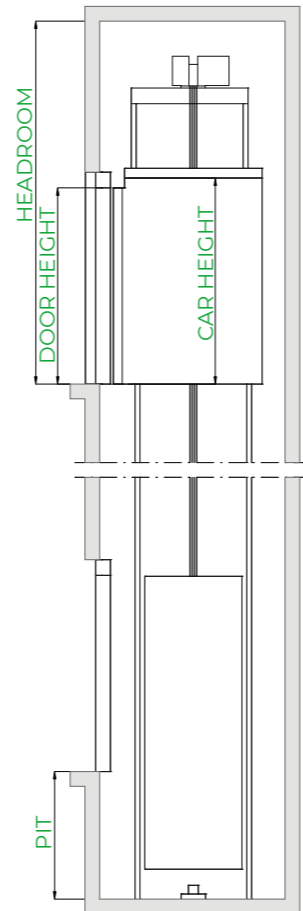

Standard **Optional**
 * R=0
 ** The information is not contractually binding and is subject to the conditions of the shaft

Accessibility solutions

Orona Next includes accessibility elements to ensure that your homelift is a universal space, so that it can be used by everyone in safe, comfortable conditions and in the most natural and independent manner.

<p>PRECISE STOPPING Optimises accessibility when entering or exiting the homelift.</p>	<p>BRaille PUSH BUTTON</p>	<p>CAR PUSH BUTTON Model with additional contrast.</p>	<p>GONG IN CAR AND ON LANDINGS Notification of the homelift reaching its destination through acoustic and visual signal.</p>	<p>ERGONOMIC HANDRAIL Heights appropriate for users either standing or in wheelchairs.</p>
<p>MULTILINGUAL VOICE SYNTHESISER Announces floor level, direction of travel and door operation.</p>	<p>SAFETY MIRROR ON THE BACK WALL Facilitates detection of obstacles when exiting.</p>	<p>PHOTOELECTRIC CURTAIN Avoids the risk of the doors hitting, allowing a safer use of the homelift.</p>	<p>AUDIBLE AND VISUAL PUSH BUTTON INFORMATION Their location, design, colour and visual / tactile (Braille) / sound operation comply with the EN 81-70 standard.</p>	

Other configurable options

- Tip-up seat.
- Visible direction arrow that displays the lift's direction of travel prior to its departure.
- Rear-view mirror.

You design, and we make it possible.

The design that envelops you, the light that surrounds you, the silence, the smooth braking or the pinpoint precision are all our way of saying that we work to make your life more comfortable, pleasant and safe.

Design your own car with
orona-ambiences.com



Discover the beauty in the details.

The wide range of aesthetic elements and the excellent quality of the materials allow you to personalise your homelift car, integrating it perfectly into the surroundings.

Orona offers you three ambiances that will serve as a source of inspiration.



HARMONIA

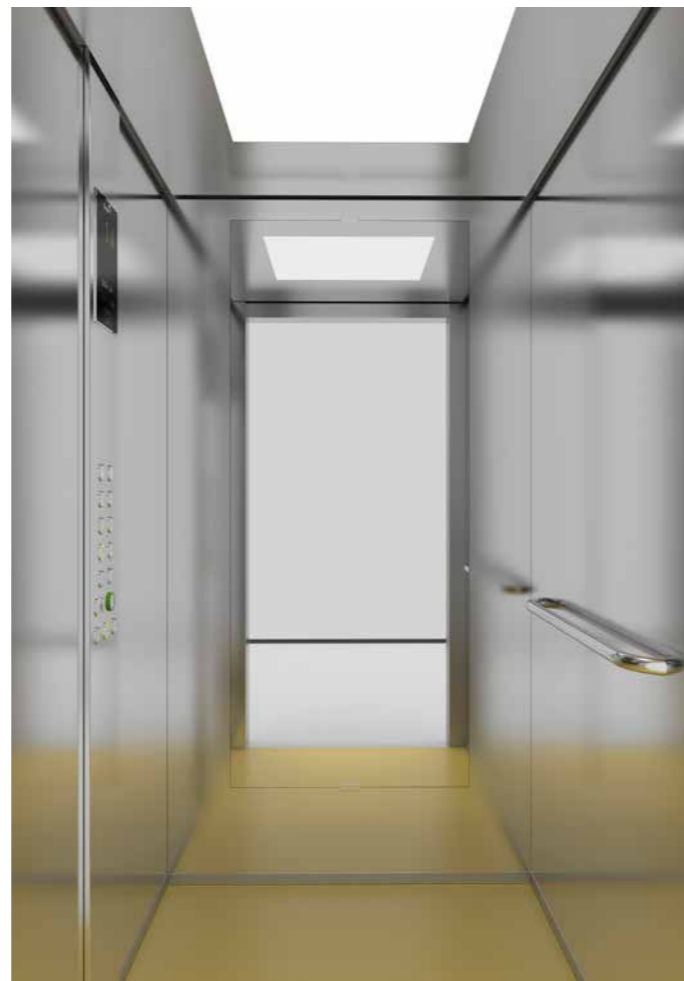

INNOVA



RINACCIA

HARMONIA

Ambiances inspired by natural elements, transmitting peace and serenity.

INNOVA

Innovation applied to design, offering refreshing trips that are full of energy.

RINACCIA

Ambiances based on timeless elements of contemporary architecture, offering an elegant experience.



Surround yourself in light.

Configure and customise the design of the car with total freedom; combine any of the elements, adapting them to the style of your building.

Ceilings and LED lighting

Automatic lighting switch-off included

Model (Standard Range)

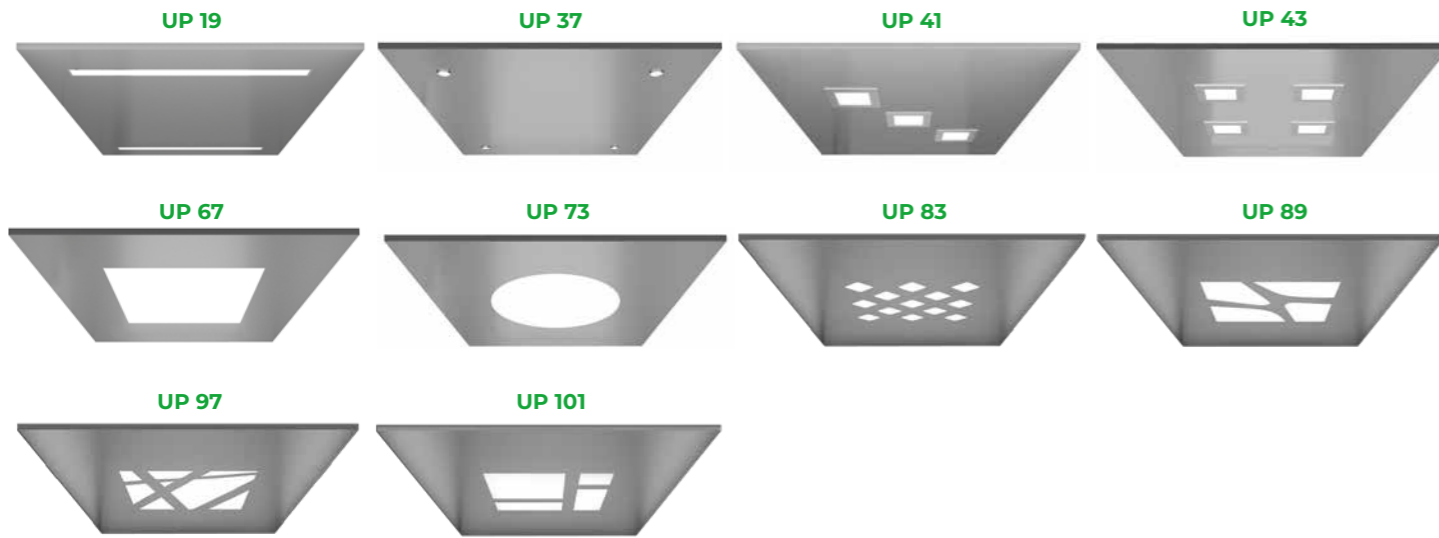

Handrails

*1 Distance to the wall: 35 mm. Also available with 50 mm (HDR 15 / HDR 16)

*2 Antimicrobial handrails



Mirrors (Standard Range)

Available in two finishes:

- White
- Fumé

*Rear-view mirror (EN 81-70).



Skirtings (Standard Range)

- SK 01 Anodized Aluminium (St St finish)
- SK 03 Black Lacquered Aluminium
- SK 11 Stainless Steel

Car walls

Neocompact Colour (Standard Range)

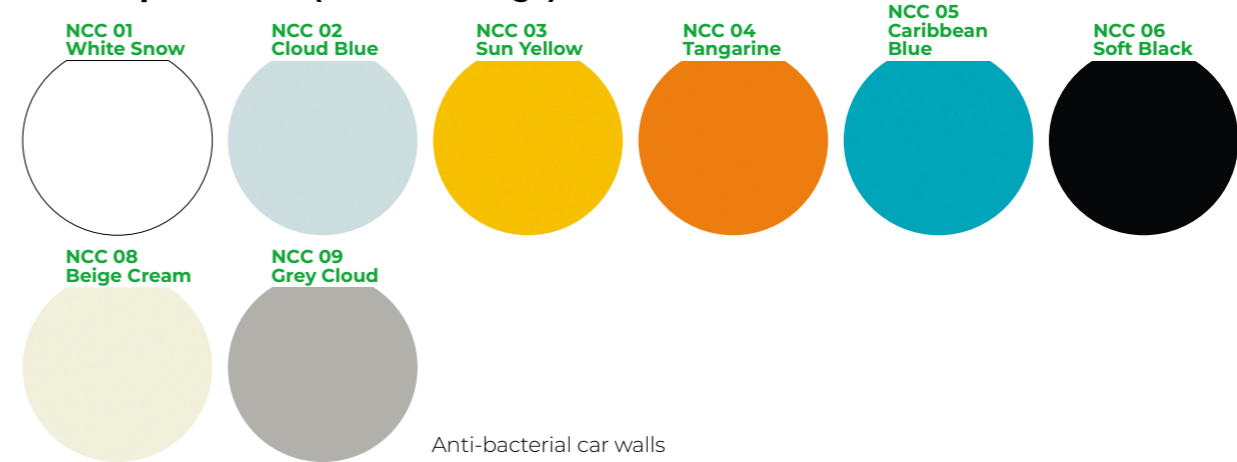

Neocompact Texture (Standard Range)



Neocompact Wood (Standard Range)



Stainless panel (Extra Charge)

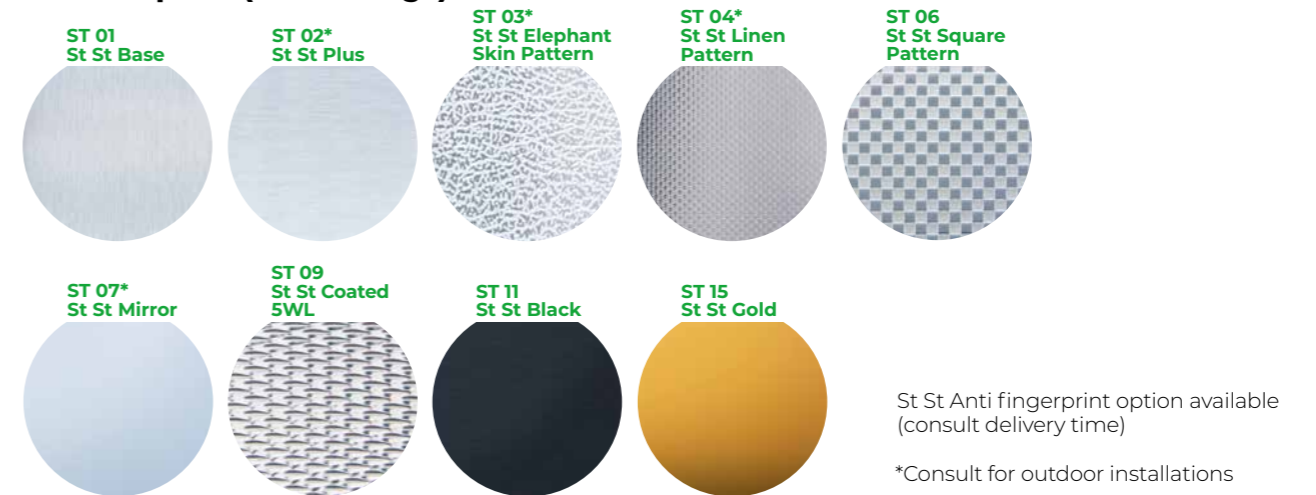

Glass ambience (Extra Charge)

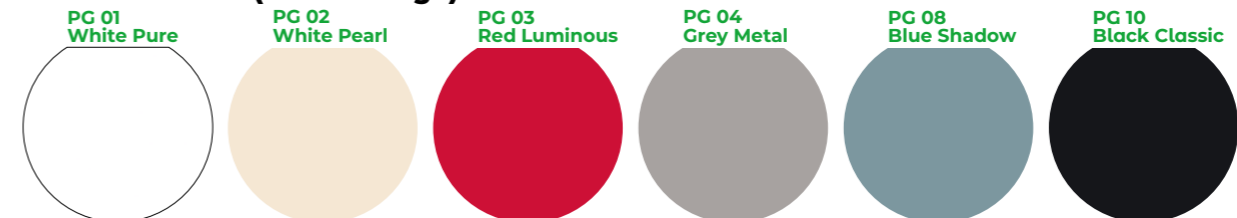

Car indicator

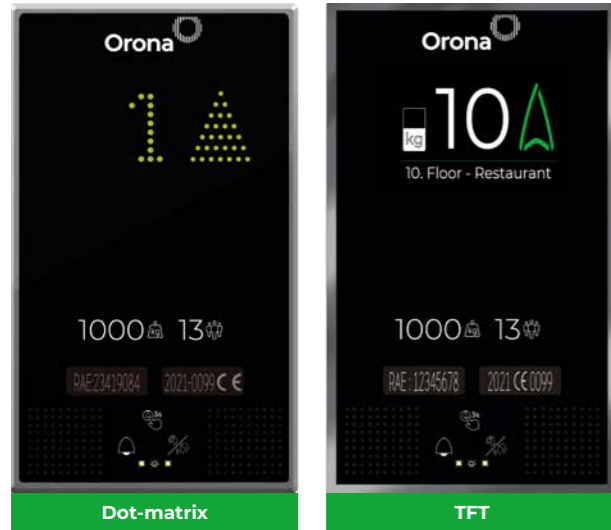

(Standard Range)

(Extra Charge)

Car operating panel

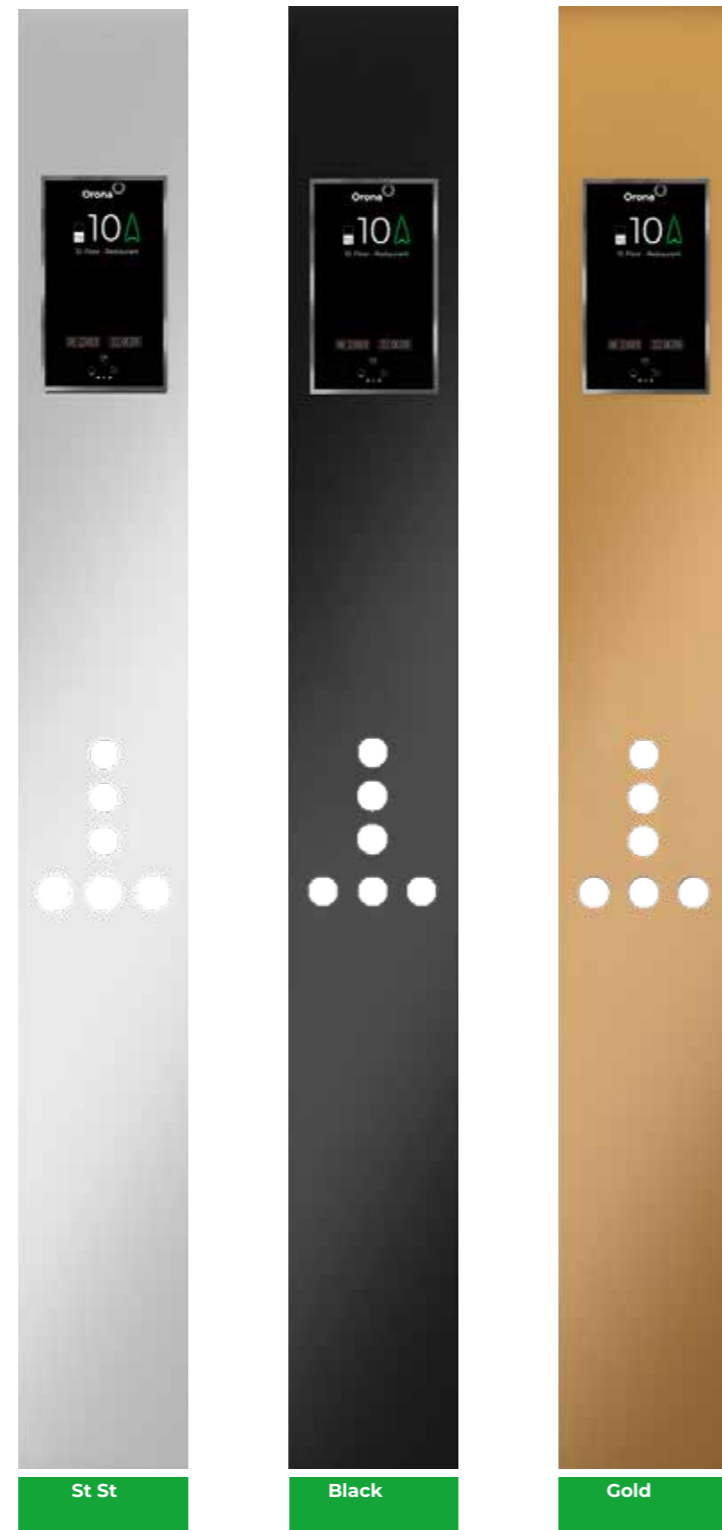

(Standard Range)

(Extra Charge)

(Extra Charge)

Car push buttons



(Standard Range)

(Extra Charge)

Car operating panel material and/or ceiling and/or doors (car and landing)

Stainless panel (ST02 - Standard Range)

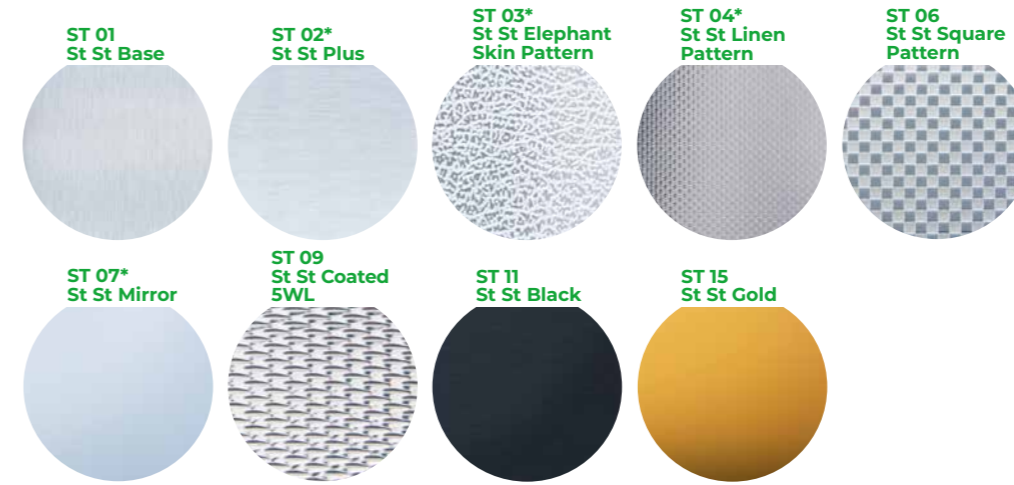

St St Anti fingerprint option available (consult delivery time)
*Consult for outdoor installations

Floor material

SC-Pvc High (Standard Range)



SW Ceramics - Available subject to dimensions (Extra Charge)

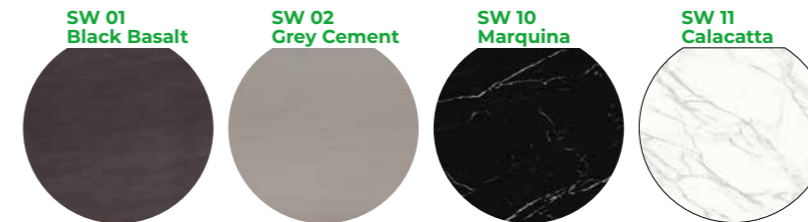

ME-Others (Extra Charge)

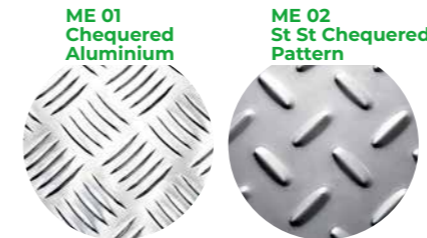

Others

- Prepared for granite (23 mm)
- Prepared for PVC (23 mm or 3 mm in restricted pits)

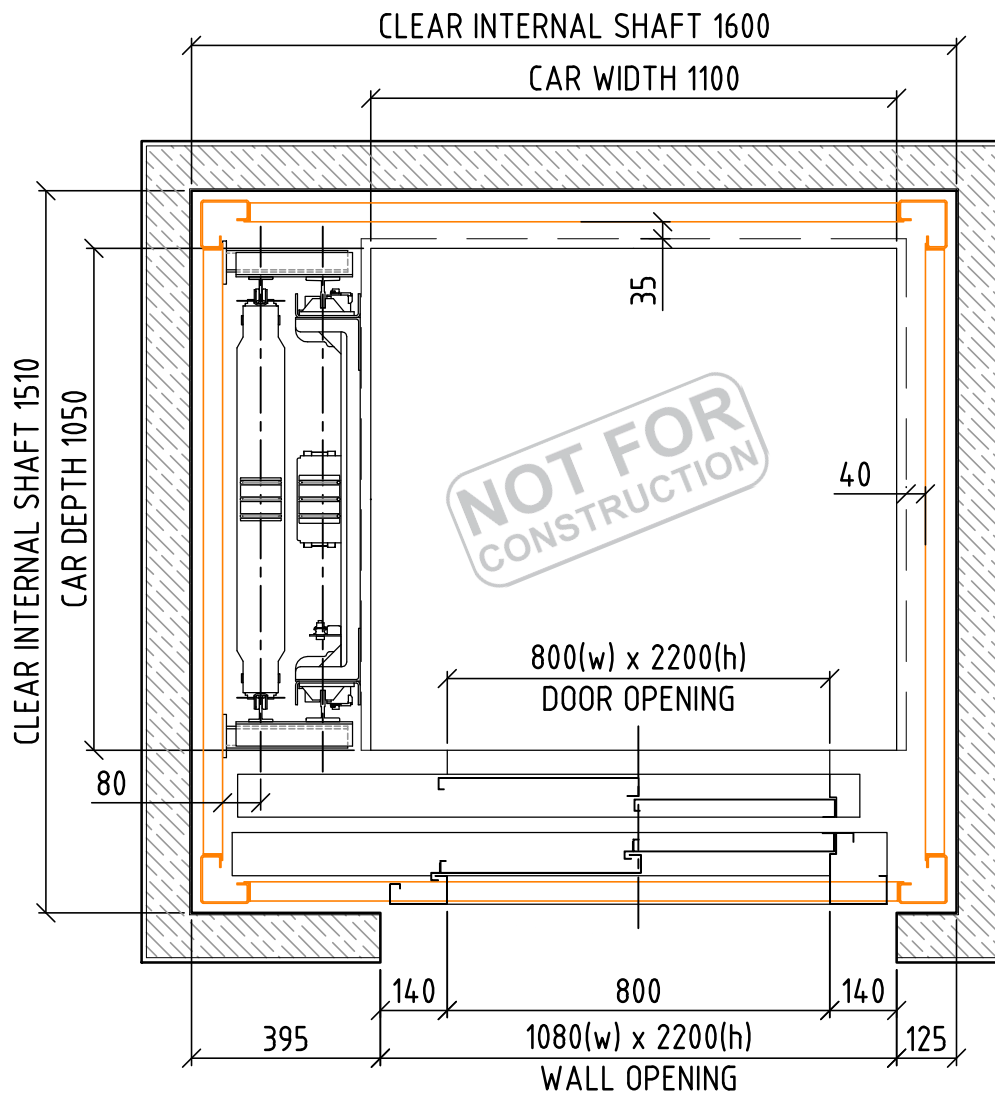

ORONA HL1-320SE-8A-ST

CAPACITY:	320kg / 4 PERSONS
TRAVEL SPEED:	0.3 m/s
CLEAR DOOR OPENING:	800mm x 2000mm
DOOR TYPE:	TWO PANEL SIDE OPENING
MINIMUM PIT:	150mm
HEADROOM:	2700mm
MAX. TRAVEL:	12m

LIFT SUPPLIED WITH INDEPENDENT STEEL SUPPORTING TOWER TO SUPPORT ALL LIFT EQUIPMENT. LIFT & TOWER TO BE INSTALLED INTO A LIGHTWEIGHT CONSTRUCTED SHAFT VOID/ENCLOSURE. REFER TO JPS LIFTS TYPICAL SHAFT ARRANGEMENT DETAIL FOR FURTHER INFORMATION.

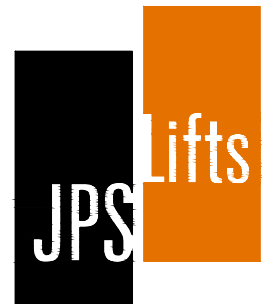

Orona

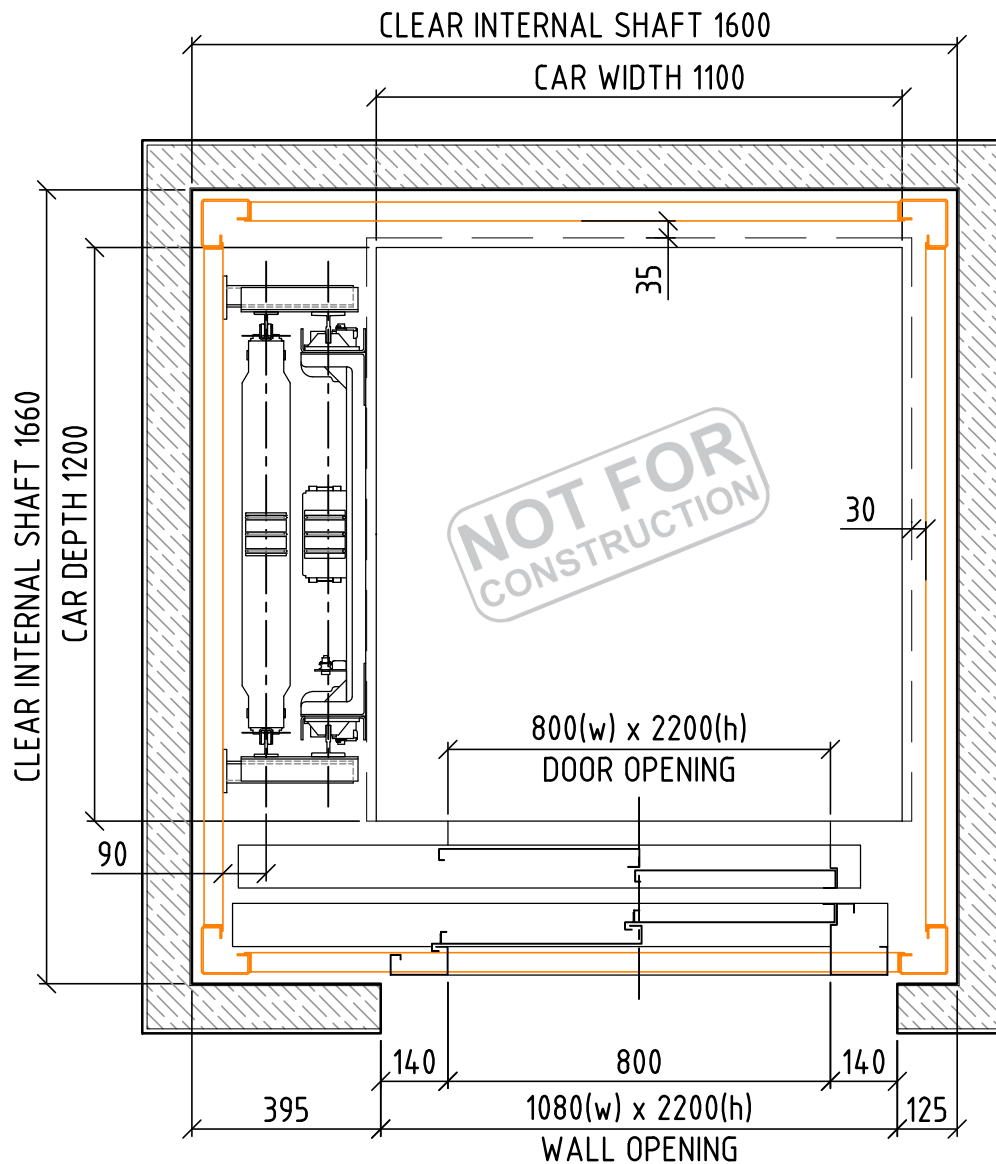

ORONA HL1-400SE-8A-ST

CAPACITY:	400kg / 5 PERSONS
TRAVEL SPEED:	0.3 m/s
CLEAR DOOR OPENING:	800mm x 2000mm
DOOR TYPE:	TWO PANEL SIDE OPENING
MINIMUM PIT:	150mm
HEADROOM:	2700mm
MAX. TRAVEL:	12m

LIFT SUPPLIED WITH INDEPENDENT STEEL SUPPORTING TOWER TO SUPPORT ALL LIFT EQUIPMENT. LIFT & TOWER TO BE INSTALLED INTO A LIGHTWEIGHT CONSTRUCTED SHAFT VOID/ENCLOSURE. REFER TO JPS LIFTS TYPICAL SHAFT ARRANGEMENT DETAIL FOR FURTHER INFORMATION.

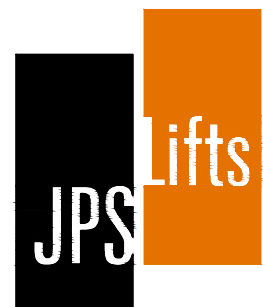

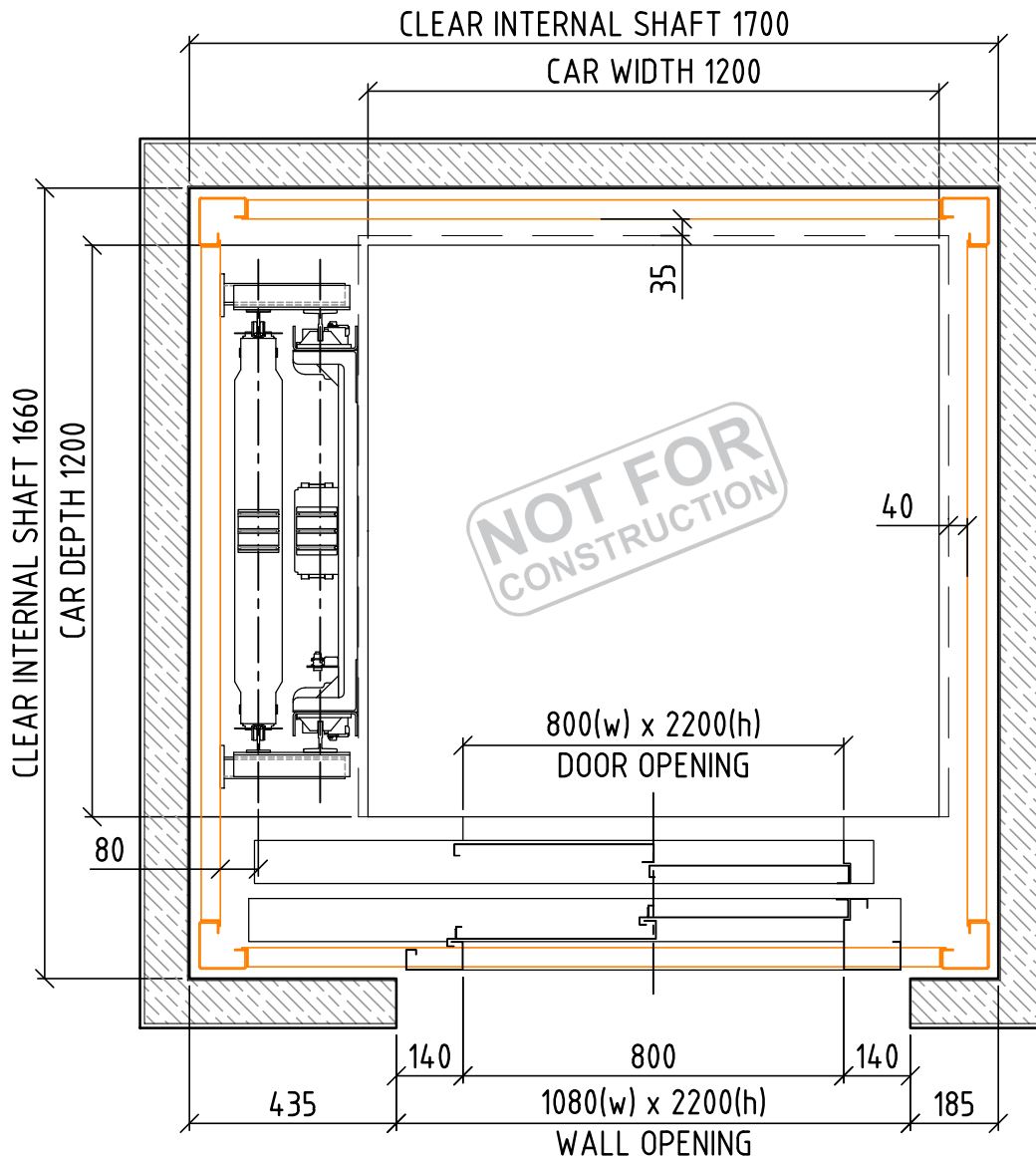

ORONA HL1-400SE-8A-ST

CAPACITY:	385kg / 5 PERSONS
TRAVEL SPEED:	0.3 m/s
CLEAR DOOR OPENING:	800mm x 2000mm
DOOR TYPE:	TWO PANEL SIDE OPENING
MINIMUM PIT:	150mm
HEADROOM:	2700mm
MAX. TRAVEL:	12m

LIFT SUPPLIED WITH INDEPENDENT STEEL SUPPORTING TOWER TO SUPPORT ALL LIFT EQUIPMENT. LIFT & TOWER TO BE INSTALLED INTO A LIGHTWEIGHT CONSTRUCTED SHAFT VOID/ENCLOSURE. REFER TO JPS LIFTS TYPICAL SHAFT ARRANGEMENT DETAIL FOR FURTHER INFORMATION.

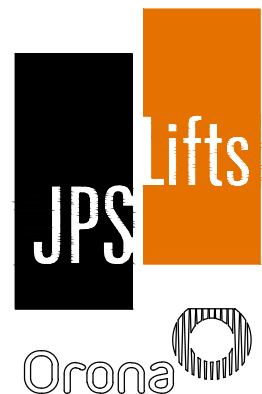

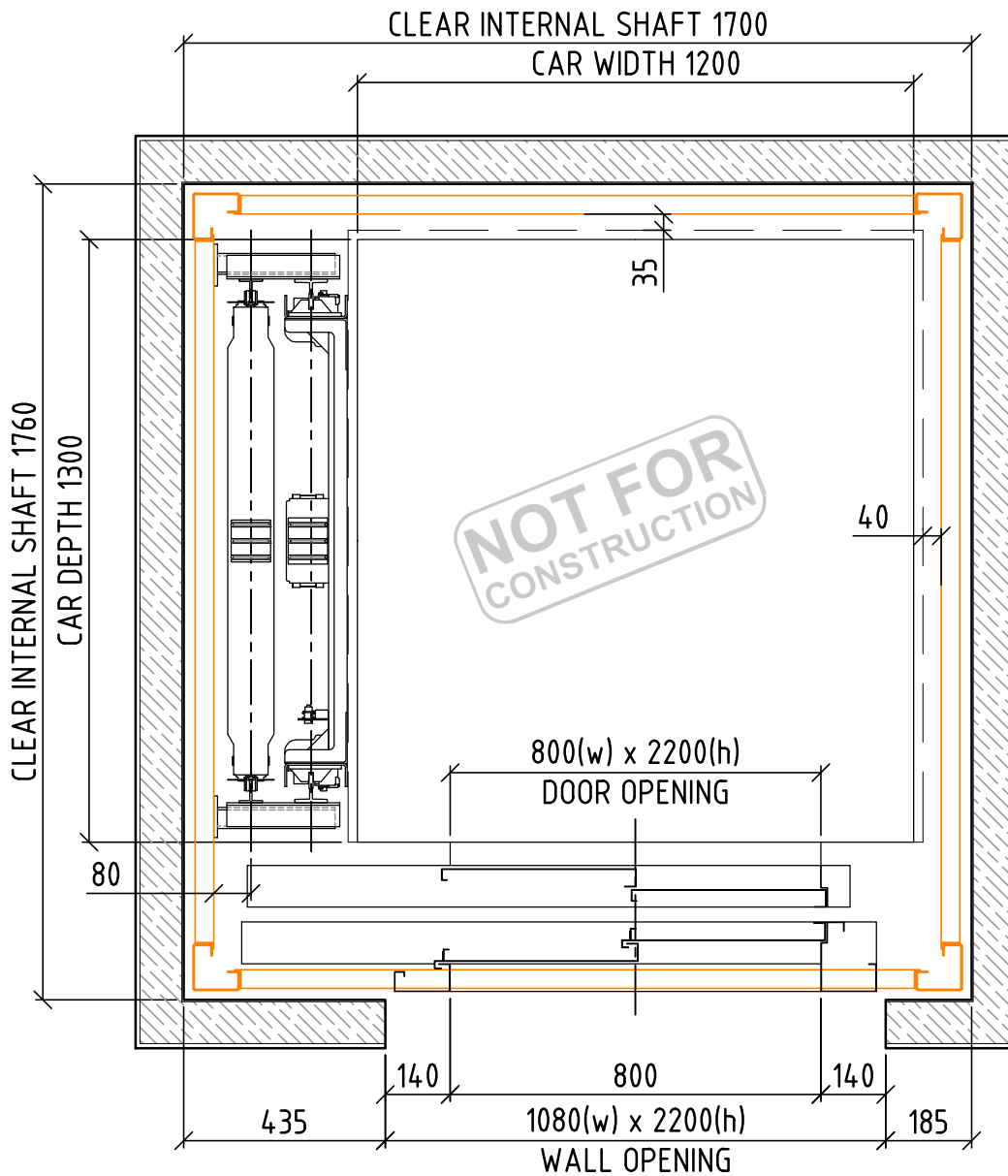

ORONA HL1-400SE-8A-ST

CAPACITY:	400kg / 5 PERSONS
TRAVEL SPEED:	0.3 m/s
CLEAR DOOR OPENING:	800mm x 2000mm
DOOR TYPE:	TWO PANEL SIDE OPENING
MINIMUM PIT:	150mm
HEADROOM:	2700mm
MAX. TRAVEL:	12m

LIFT SUPPLIED WITH INDEPENDENT STEEL SUPPORTING TOWER TO SUPPORT ALL LIFT EQUIPMENT. LIFT & TOWER TO BE INSTALLED INTO A LIGHTWEIGHT CONSTRUCTED SHAFT VOID/ENCLOSURE. REFER TO JPS LIFTS TYPICAL SHAFT ARRANGEMENT DETAIL FOR FURTHER INFORMATION.

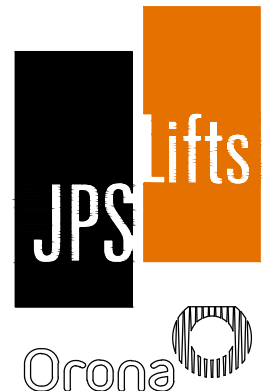

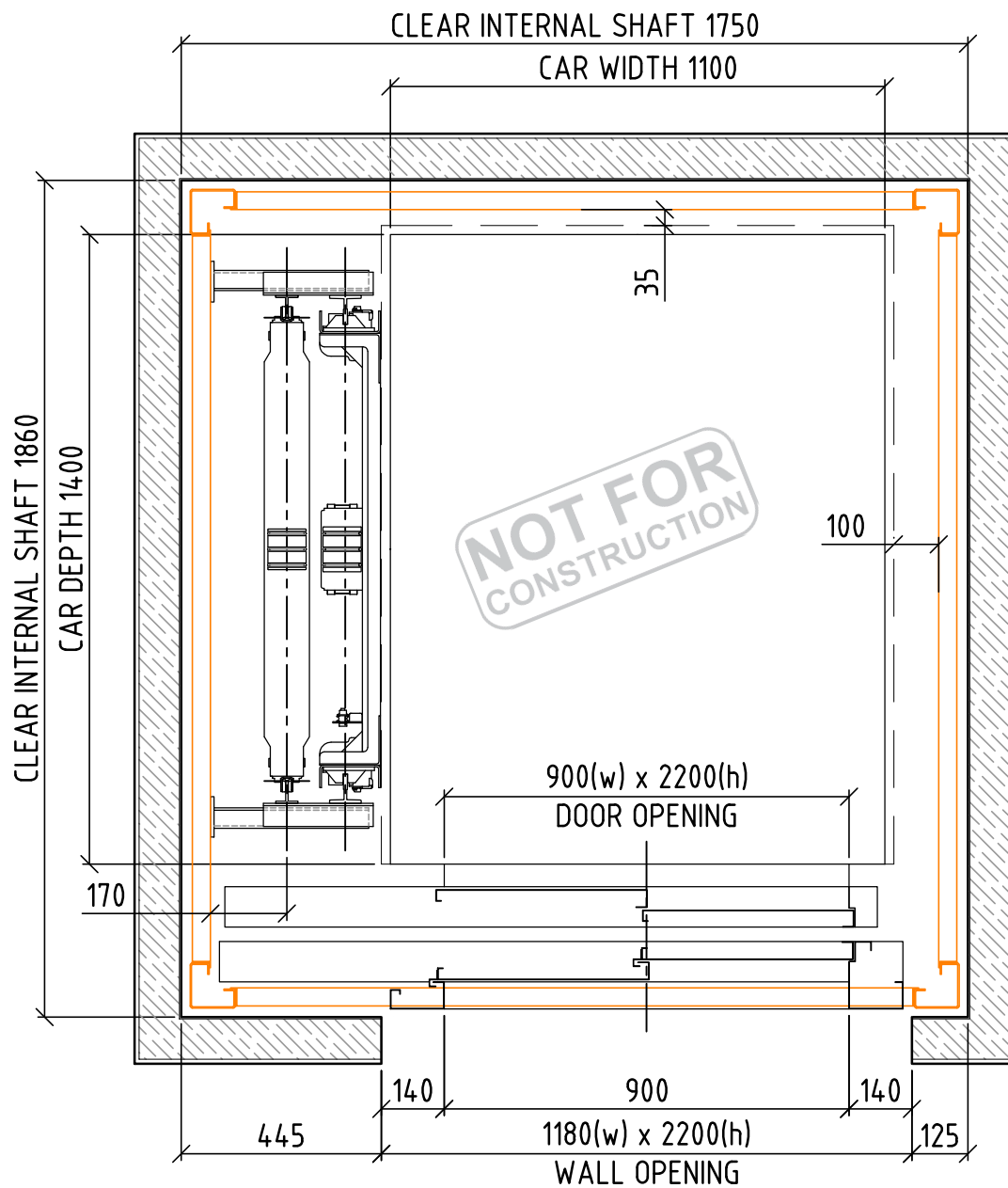

ORONA HL1-400SE-9A-ST

CAPACITY:	400kg / 5 PERSONS
TRAVEL SPEED:	0.3 m/s
CLEAR DOOR OPENING:	900mm x 2000mm
DOOR TYPE:	TWO PANEL SIDE OPENING
MINIMUM PIT:	150mm
HEADROOM:	2700mm
MAX. TRAVEL:	12m

LIFT SUPPLIED WITH INDEPENDENT STEEL SUPPORTING TOWER TO SUPPORT ALL LIFT EQUIPMENT. LIFT & TOWER TO BE INSTALLED INTO A LIGHTWEIGHT CONSTRUCTED SHAFT VOID/ENCLOSURE. REFER TO JPS LIFTS TYPICAL SHAFT ARRANGEMENT DETAIL FOR FURTHER INFORMATION.

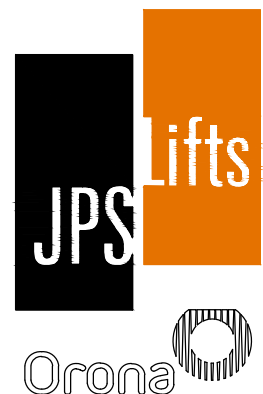

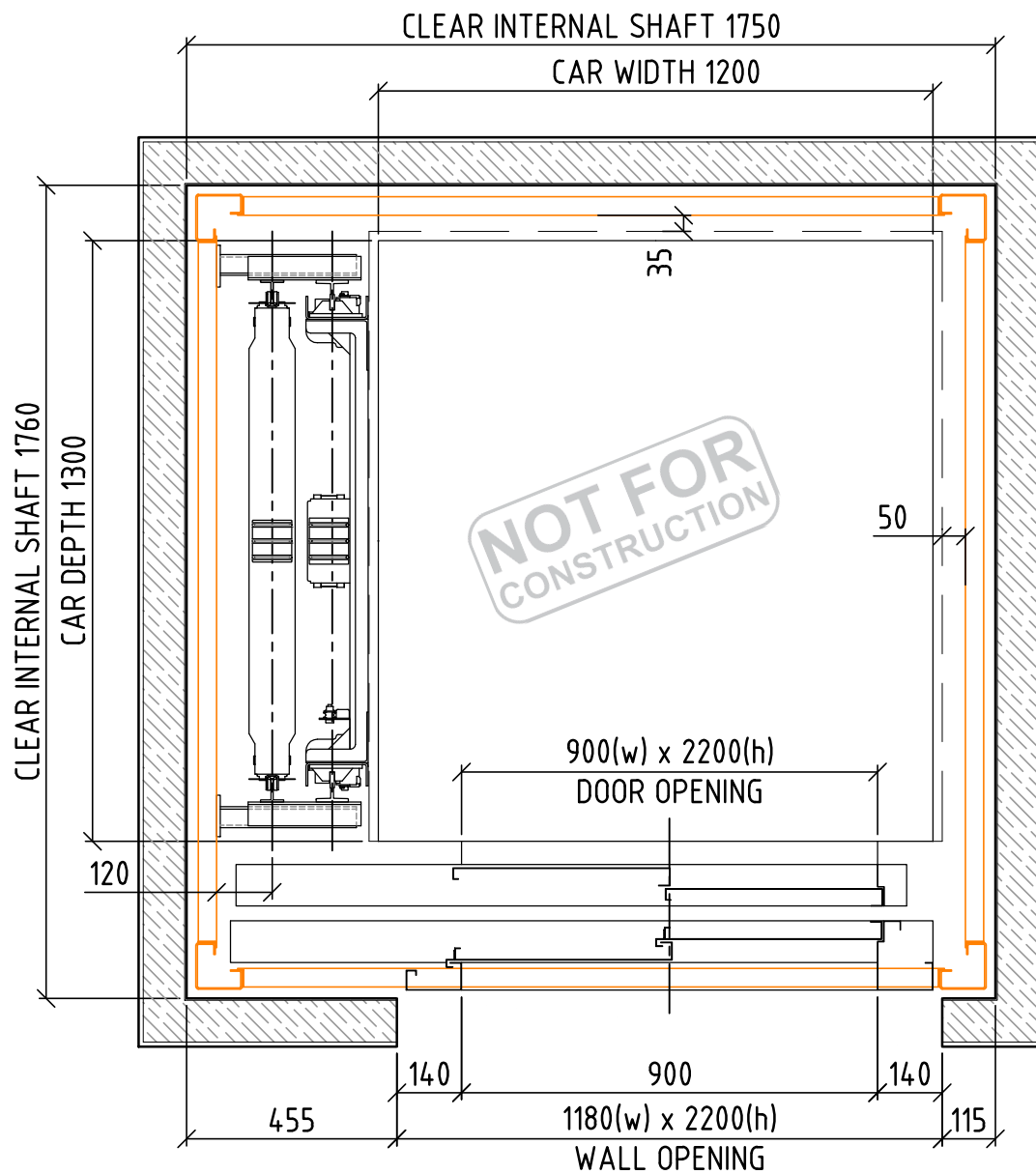

ORONA HL1-400SE-9A-ST

CAPACITY:	400kg / 5 PERSONS
TRAVEL SPEED:	0.3 m/s
CLEAR DOOR OPENING:	900mm x 2000mm
DOOR TYPE:	TWO PANEL SIDE OPENING
MINIMUM PIT:	150mm
HEADROOM:	2700mm
MAX. TRAVEL:	12m

LIFT SUPPLIED WITH INDEPENDENT STEEL SUPPORTING TOWER TO SUPPORT ALL LIFT EQUIPMENT. LIFT & TOWER TO BE INSTALLED INTO A LIGHTWEIGHT CONSTRUCTED SHAFT VOID/ENCLOSURE. REFER TO JPS LIFTS TYPICAL SHAFT ARRANGEMENT DETAIL FOR FURTHER INFORMATION.

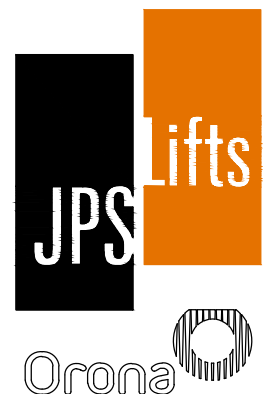

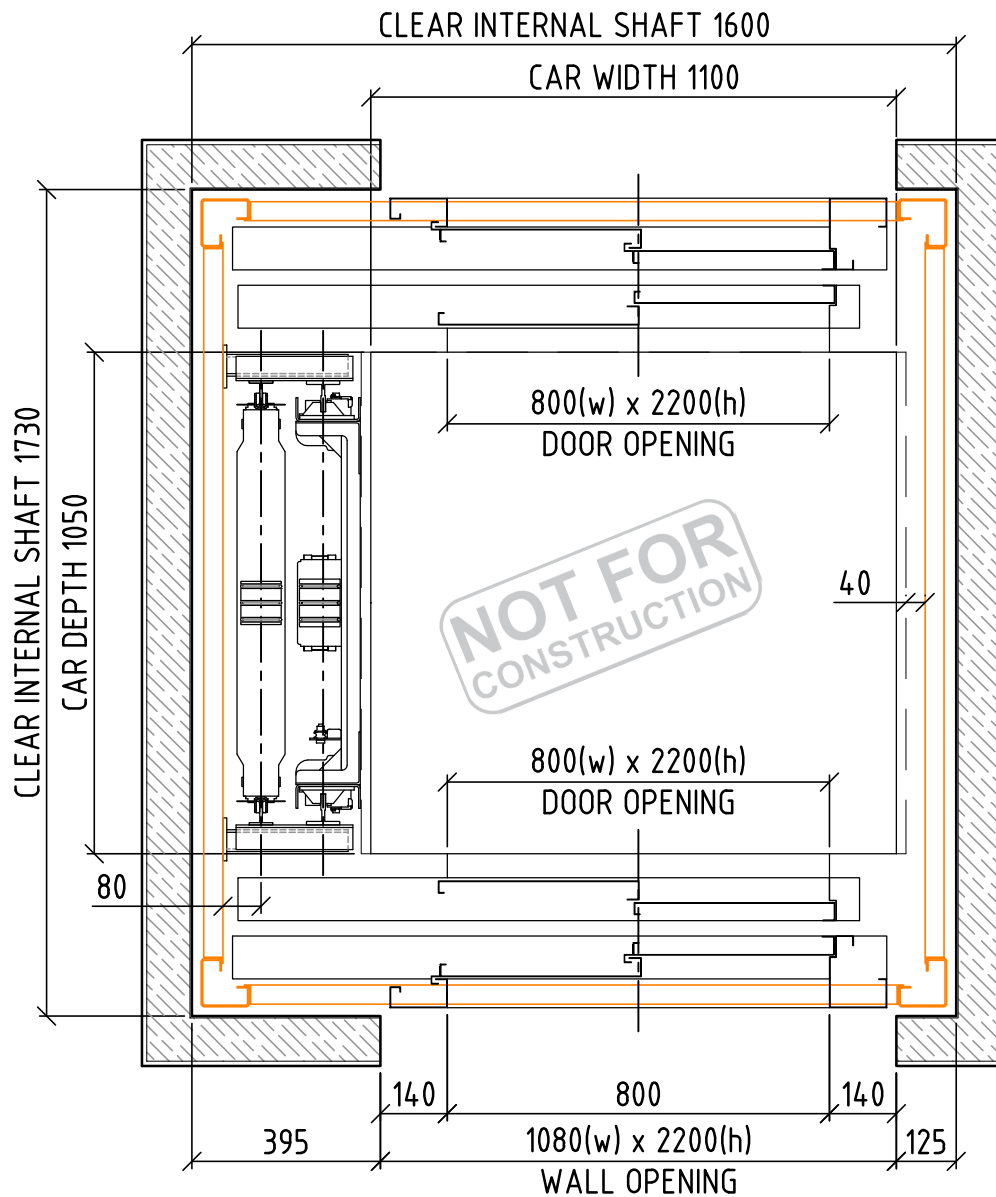

ORONA HL1-320DE-8A-ST

CAPACITY:	320kg / 4 PERSONS
TRAVEL SPEED:	0.3 m/s
CLEAR DOOR OPENING:	800mm x 2000mm
DOOR TYPE:	TWO PANEL SIDE OPENING
MINIMUM PIT:	150mm
HEADROOM:	2700mm
MAX. TRAVEL:	12m

LIFT SUPPLIED WITH INDEPENDENT STEEL SUPPORTING TOWER TO SUPPORT ALL LIFT EQUIPMENT. LIFT & TOWER TO BE INSTALLED INTO A LIGHTWEIGHT CONSTRUCTED SHAFT VOID/ENCLOSURE. REFER TO JPS LIFTS TYPICAL SHAFT ARRANGEMENT DETAIL FOR FURTHER INFORMATION.

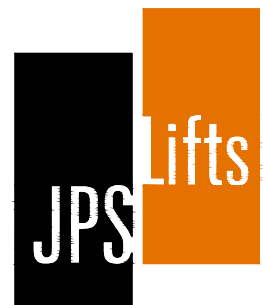

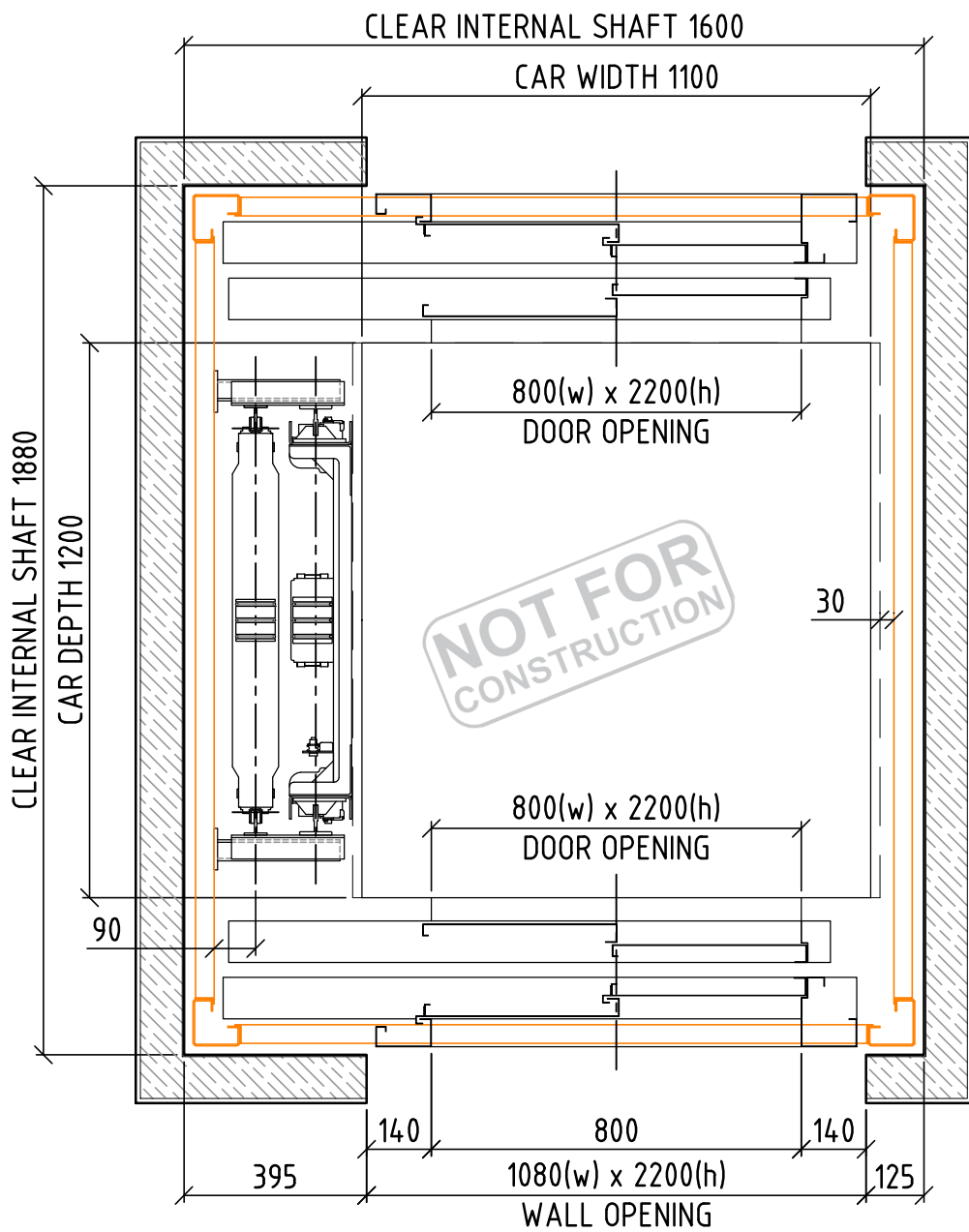

ORONA HL1-400DE-8A-ST

CAPACITY:	400kg / 5 PERSONS
TRAVEL SPEED:	0.3 m/s
CLEAR DOOR OPENING:	800mm x 2000mm
DOOR TYPE:	TWO PANEL SIDE OPENING
MINIMUM PIT:	150mm
HEADROOM:	2700mm
MAX. TRAVEL:	12m

LIFT SUPPLIED WITH INDEPENDENT STEEL SUPPORTING TOWER TO SUPPORT ALL LIFT EQUIPMENT. LIFT & TOWER TO BE INSTALLED INTO A LIGHTWEIGHT CONSTRUCTED SHAFT VOID/ENCLOSURE. REFER TO JPS LIFTS TYPICAL SHAFT ARRANGEMENT DETAIL FOR FURTHER INFORMATION.

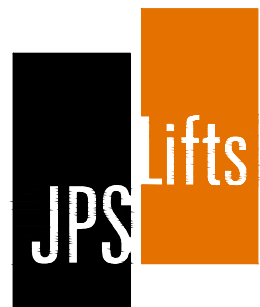

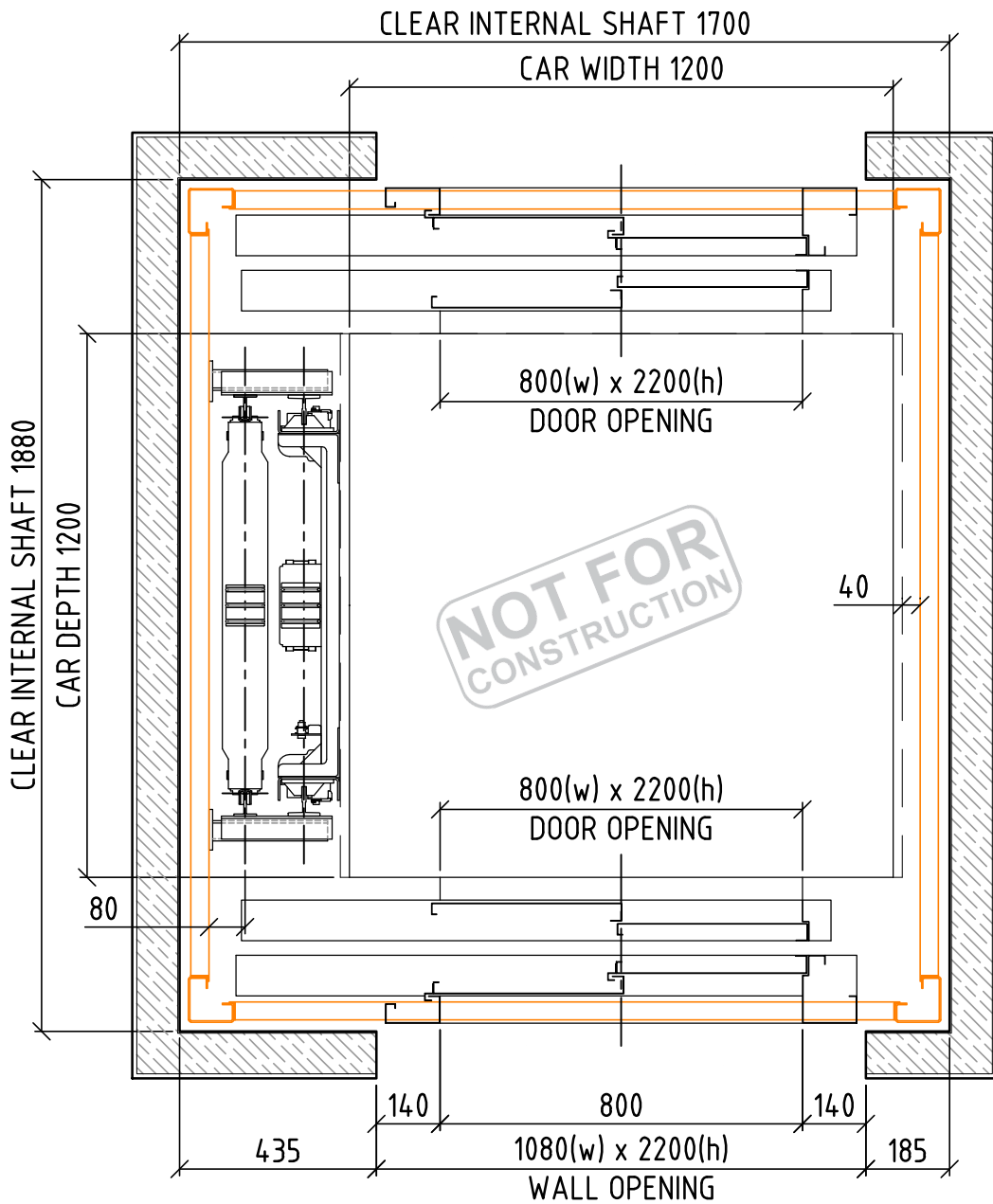

ORONA HL1-400DE-8A-ST

CAPACITY:	400kg / 5 PERSONS
TRAVEL SPEED:	0.3 m/s
CLEAR DOOR OPENING:	800mm x 2000mm
DOOR TYPE:	TWO PANEL SIDE OPENING
MINIMUM PIT:	150mm
HEADROOM:	2700mm
MAX. TRAVEL:	12m

LIFT SUPPLIED WITH INDEPENDENT STEEL SUPPORTING TOWER TO SUPPORT ALL LIFT EQUIPMENT. LIFT & TOWER TO BE INSTALLED INTO A LIGHTWEIGHT CONSTRUCTED SHAFT VOID/ENCLOSURE. REFER TO JPS LIFTS TYPICAL SHAFT ARRANGEMENT DETAIL FOR FURTHER INFORMATION.

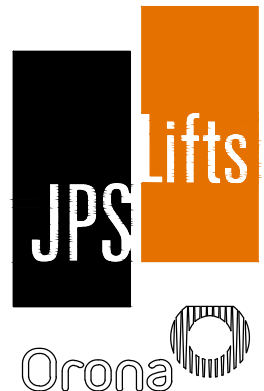

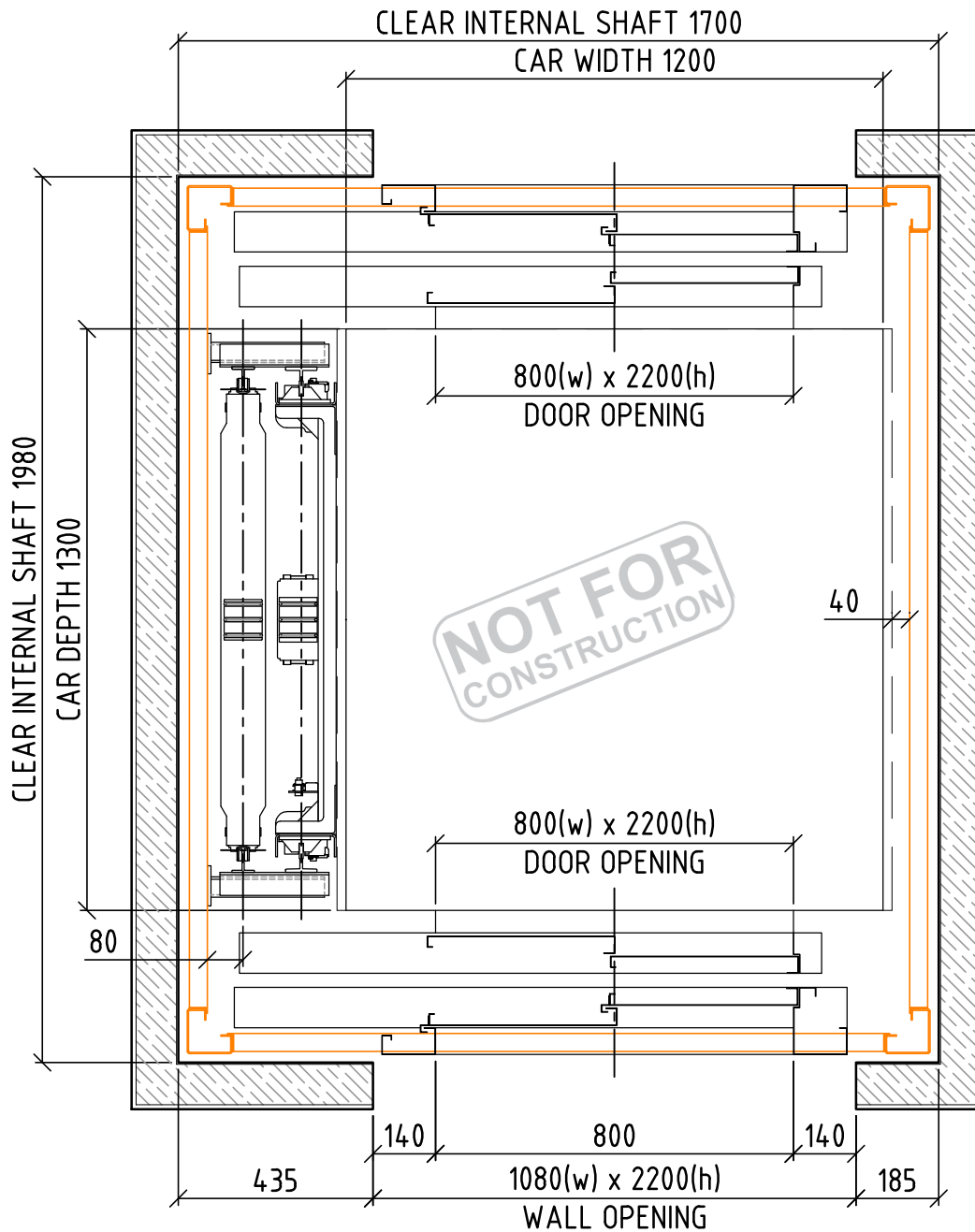

ORONA HL1-400DE-8A-ST

CAPACITY:	400kg / 5 PERSONS
TRAVEL SPEED:	0.3 m/s
CLEAR DOOR OPENING:	800mm x 2000mm
DOOR TYPE:	TWO PANEL SIDE OPENING
MINIMUM PIT:	150mm
HEADROOM:	2700mm
MAX. TRAVEL:	12m

LIFT SUPPLIED WITH INDEPENDENT STEEL SUPPORTING TOWER TO SUPPORT ALL LIFT EQUIPMENT. LIFT & TOWER TO BE INSTALLED INTO A LIGHTWEIGHT CONSTRUCTED SHAFT VOID/ENCLOSURE. REFER TO JPS LIFTS TYPICAL SHAFT ARRANGEMENT DETAIL FOR FURTHER INFORMATION.

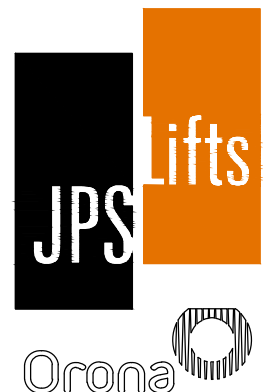

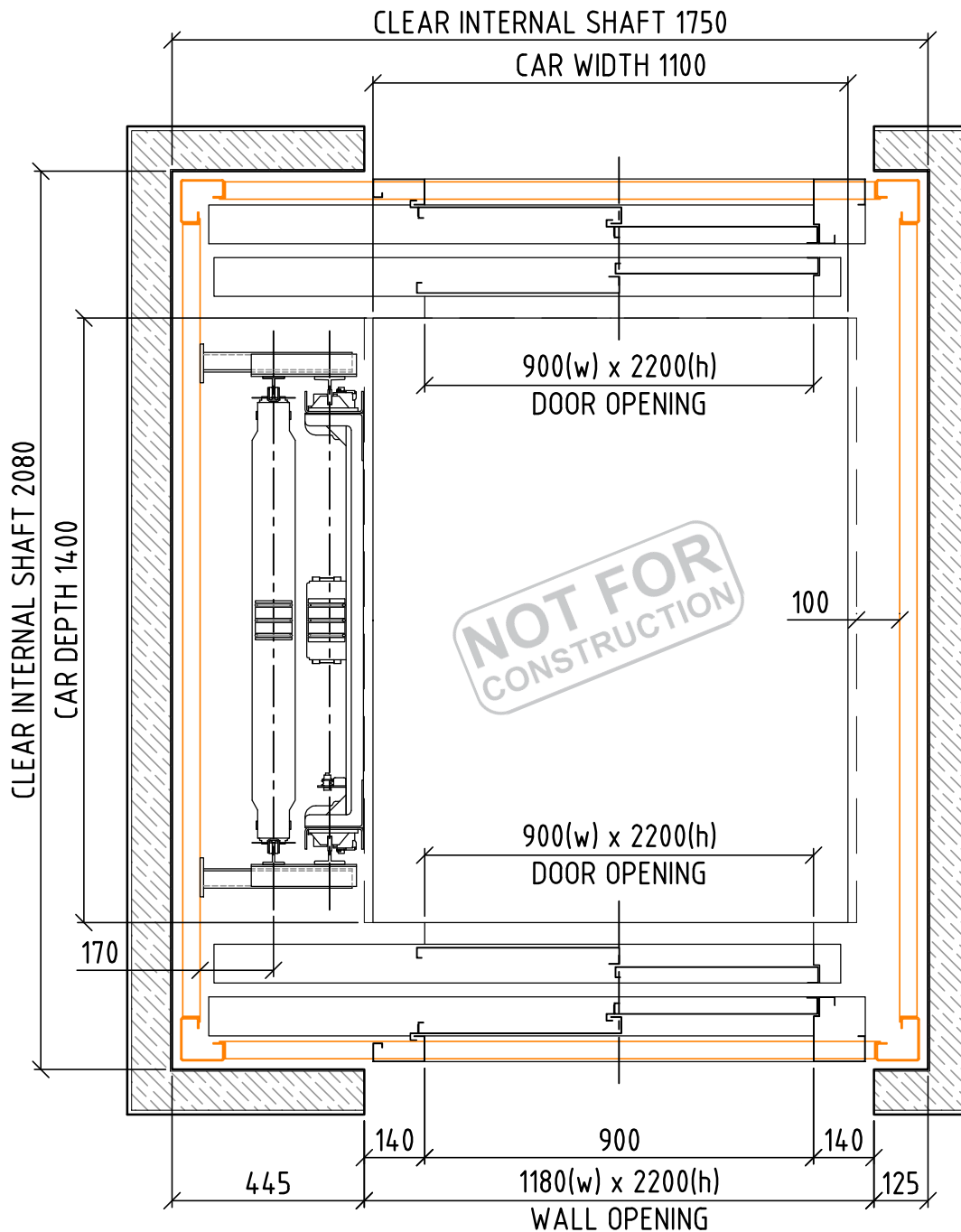

ORONA HL1-400DE-9A-ST

CAPACITY:	400kg / 5 PERSONS
TRAVEL SPEED:	0.3 m/s
CLEAR DOOR OPENING:	900mm x 2000mm
DOOR TYPE:	TWO PANEL SIDE OPENING
MINIMUM PIT:	150mm
HEADROOM:	2700mm
MAX. TRAVEL:	12m

LIFT SUPPLIED WITH INDEPENDENT STEEL SUPPORTING TOWER TO SUPPORT ALL LIFT EQUIPMENT. LIFT & TOWER TO BE INSTALLED INTO A LIGHTWEIGHT CONSTRUCTED SHAFT VOID/ENCLOSURE. REFER TO JPS LIFTS TYPICAL SHAFT ARRANGEMENT DETAIL FOR FURTHER INFORMATION.



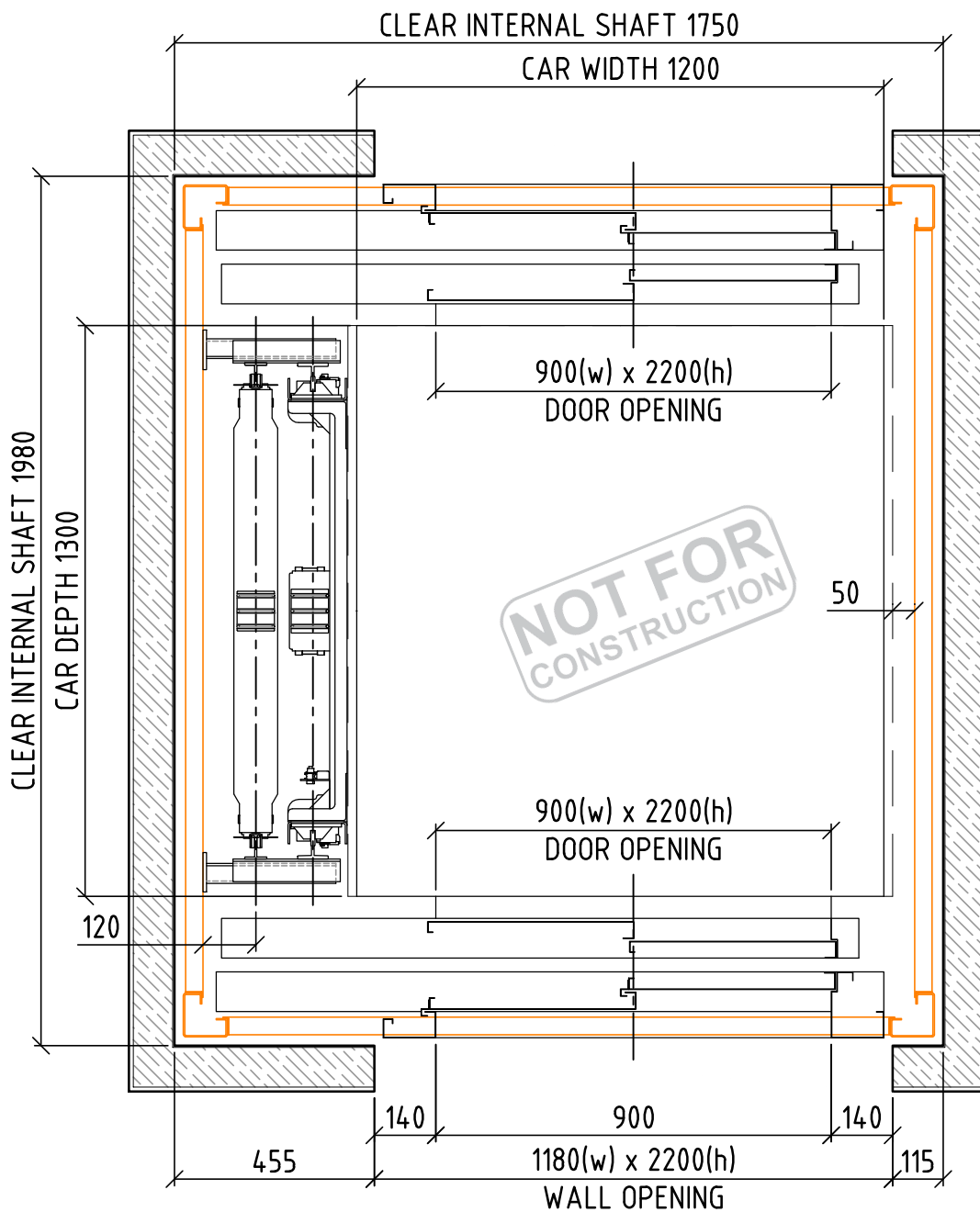

ORONA HL1-400DE-9A-ST

CAPACITY:	400kg / 5 PERSONS
TRAVEL SPEED:	0.3 m/s
CLEAR DOOR OPENING:	900mm x 2000mm
DOOR TYPE:	TWO PANEL SIDE OPENING
MINIMUM PIT:	150mm
HEADROOM:	2700mm
MAX. TRAVEL:	12m

LIFT SUPPLIED WITH INDEPENDENT STEEL SUPPORTING TOWER TO SUPPORT ALL LIFT EQUIPMENT. LIFT & TOWER TO BE INSTALLED INTO A LIGHTWEIGHT CONSTRUCTED SHAFT VOID/ENCLOSURE. REFER TO JPS LIFTS TYPICAL SHAFT ARRANGEMENT DETAIL FOR FURTHER INFORMATION.



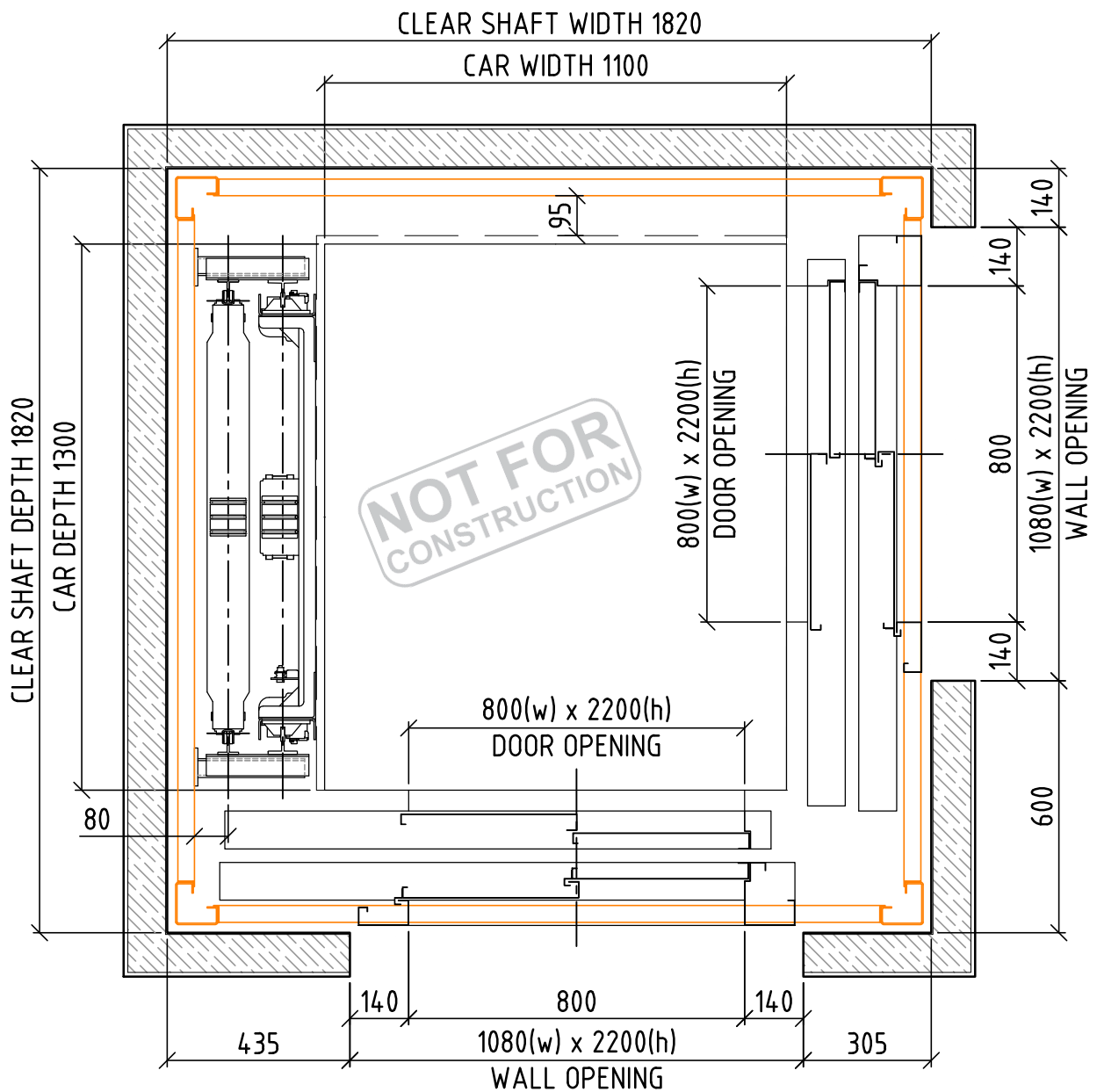

ORONA HL1-400AD-8A-ST

CAPACITY:	400kg / 5 PERSONS
TRAVEL SPEED:	0.3 m/s
CLEAR DOOR OPENING:	800mm x 2000mm
DOOR TYPE:	TWO PANEL SIDE OPENING
MINIMUM PIT:	150mm
HEADROOM:	2700mm
MAX. TRAVEL:	12m

LIFT SUPPLIED WITH INDEPENDENT STEEL SUPPORTING TOWER TO SUPPORT ALL LIFT EQUIPMENT. LIFT & TOWER TO BE INSTALLED INTO A LIGHTWEIGHT CONSTRUCTED SHAFT VOID/ENCLOSURE. REFER TO JPS LIFTS TYPICAL SHAFT ARRANGEMENT DETAIL FOR FURTHER INFORMATION.

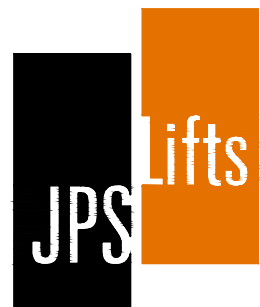

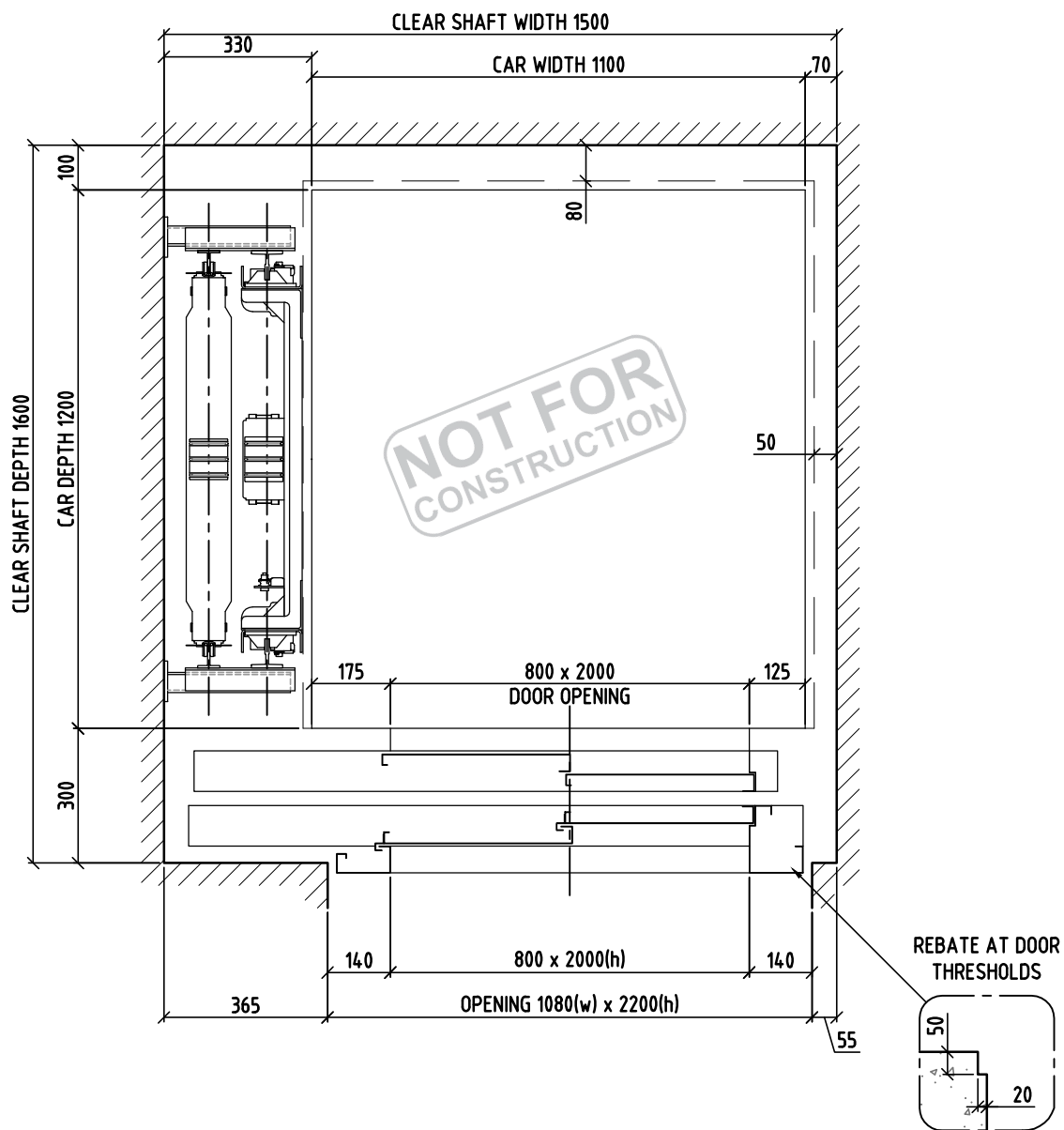

ORONA HL1-400SE-8A-LB

CAPACITY:	400kg / 5 PERSONS
TRAVEL SPEED:	0.3 m/s
CLEAR DOOR OPENING:	800mm x 2000mm
DOOR TYPE:	TWO PANEL SIDE OPENING
MINIMUM PIT:	150mm
HEADROOM:	2700mm
MAX. TRAVEL:	12m

LIFT TO BE INSTALLED IN
LOAD BEARING SHAFT IN
EITHER MASONRY CORE
FILLED BLOCK WORK OR
PRECAST CONCRETE PANELS

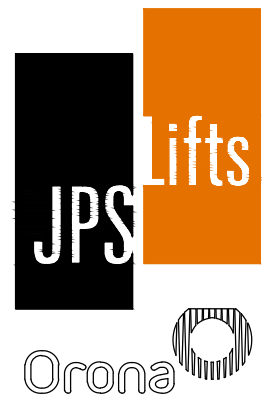

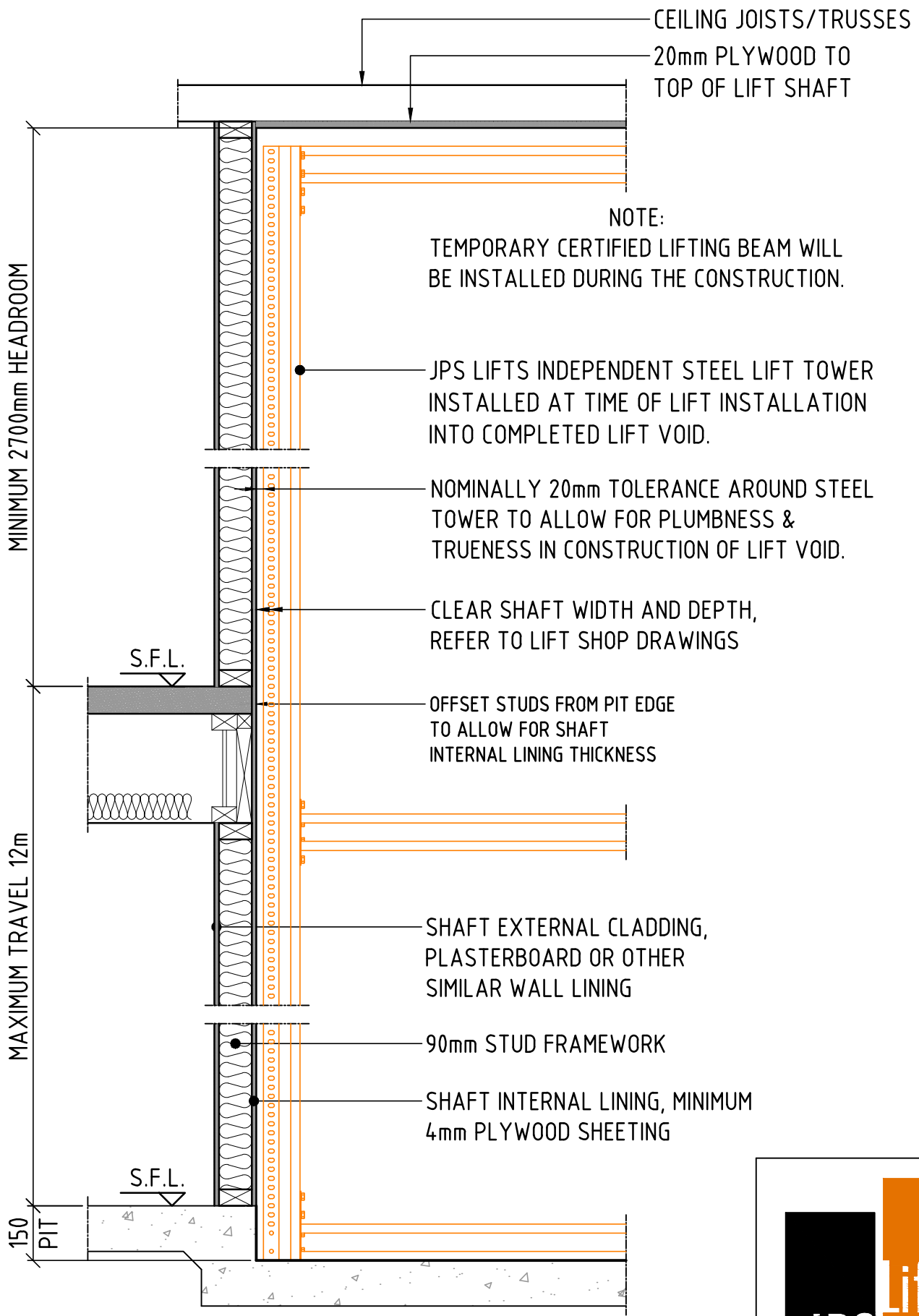

CEILING JOISTS/TRUSSES
 20mm PLYWOOD TO TOP OF LIFT SHAFT

MINIMUM 2700mm HEADROOM

MAXIMUM TRAVEL 12m

150
PIT

NOTE:
 TEMPORARY CERTIFIED LIFTING BEAM WILL BE INSTALLED DURING THE CONSTRUCTION.

JPS LIFTS INDEPENDENT STEEL LIFT TOWER INSTALLED AT TIME OF LIFT INSTALLATION INTO COMPLETED LIFT VOID.

NOMINALLY 20mm TOLERANCE AROUND STEEL TOWER TO ALLOW FOR PLUMBNESS & TRUENESS IN CONSTRUCTION OF LIFT VOID.

CLEAR SHAFT WIDTH AND DEPTH, REFER TO LIFT SHOP DRAWINGS

S.F.L.

OFFSET STUDS FROM PIT EDGE TO ALLOW FOR SHAFT INTERNAL LINING THICKNESS

SHAFT EXTERNAL CLADDING, PLASTERBOARD OR OTHER SIMILAR WALL LINING

90mm STUD FRAMEWORK

SHAFT INTERNAL LINING, MINIMUM 4mm PLYWOOD SHEETING

S.F.L.

TYPICAL SHAFT VOID/ENCLOSURE DETAIL
 NOT TO SCALE

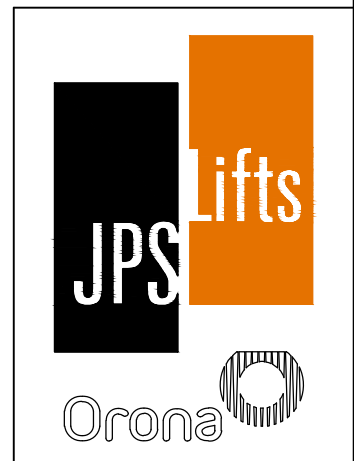

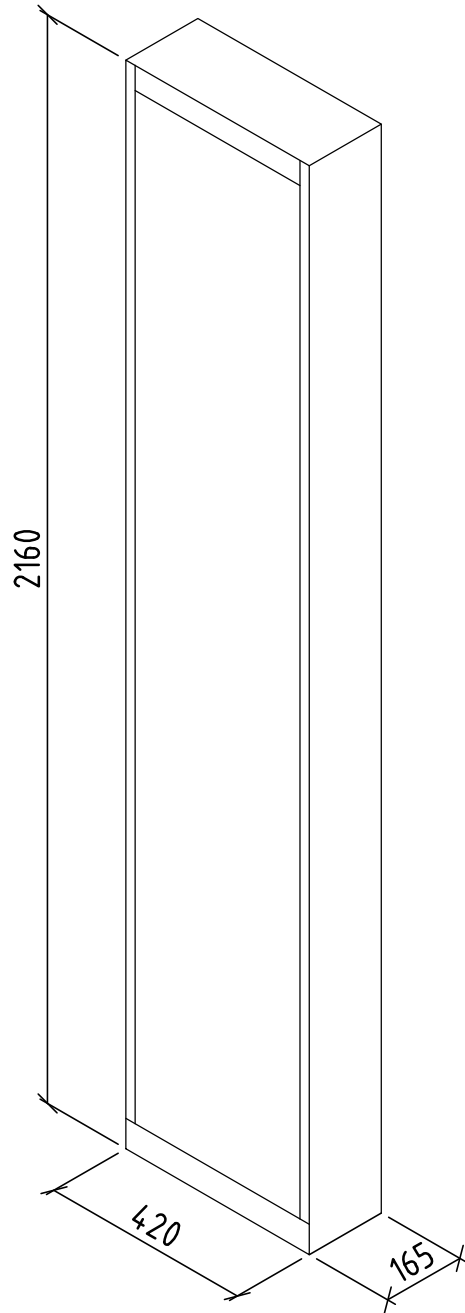

NOTES:

1. LIFT CONTROLLER DOOR CAN BE INSTALLED TO SWING LH OR RH HINGE.
2. PLACEMENT OF THE LIFT CONTROLLER
 - 2.1. MUST BE IN A DRY AREA THAT HAS GOOD ACCESS AND LIGHTING.
 - 2.2. TO BE PLACED ON ONE WALL OF THE SHAFT ON ANY LEVEL.
 - 2.3. CONTROLLER CAN BE PLACED PARALLEL TO THE LIFT DOORS INSIDE A CUPBOARD.
 - 2.4. CLEAR WORKING AREA 500(w) X 700(d) X 2100(h) TO BE MAINTAINED IN FRONT OF CONTROLLER.

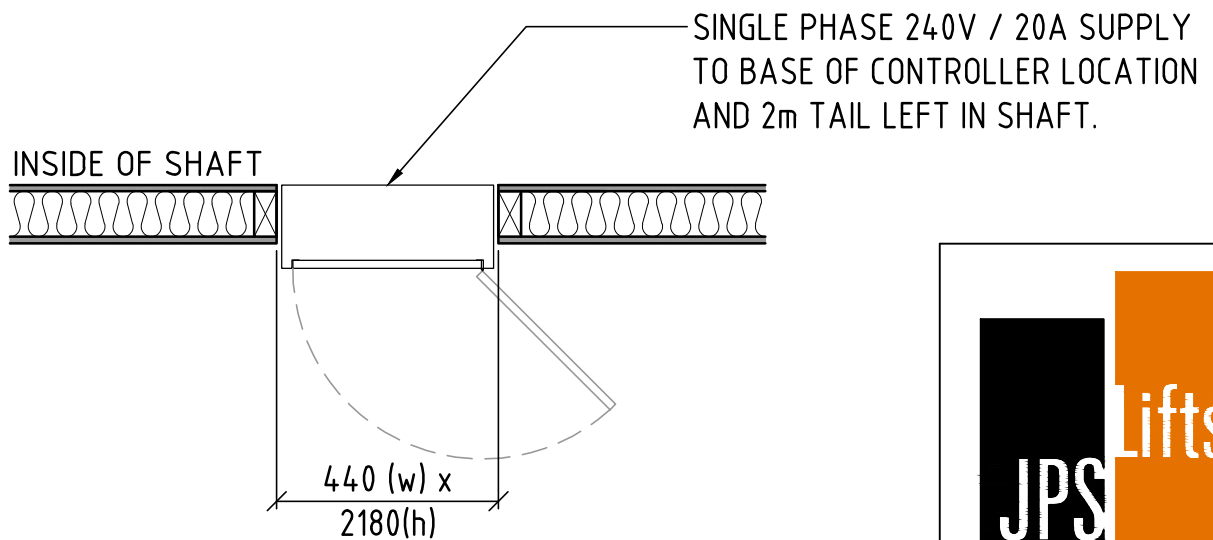

TYPICAL LIFT CONTROLLER DETAIL
NOT TO SCALE

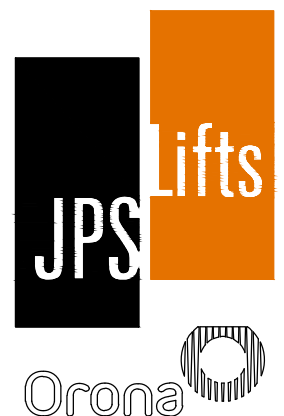

ORONA